



QUALITY... PLAIN & SIMPLE®

GM Tailmount Automatic Transmission Shifter Installation Instructions

General Installation Notes:

Please read these instructions completely before beginning the installation. If you have any questions, please call.

Before beginning the installation, disconnect the negative battery cable and use wheel chocks to block the vehicle's wheels.

Make sure the engine, transmission, body, and frame are properly grounded.

All Lokar Installation Instructions can be found by visiting www.lokar.com/instructions.html.

Refer to Fig. 1 for the component names.

Tools and Materials Required:

- Standard Allen wrenches: 1/8", 5/32", 3/16", 7/32"
- Wrench or Socket Sizes: 5/16", 3/8", 7/16", 1/2", 9/16", 5/8", 7/8", 13mm (metric transmissions only)
- Tape Measure
- Metal cutting tool, such as a hacksaw or a die grinder with a cut-off wheel
- Ohmmeter
- Wire cutters/strippers
- Wire crimping or soldering tools
- Blue thread locking compound

Lokar Shifters are designed to fit specific transmissions. Before installing the Shifter, verify that you have the proper model for your transmission. If your Shifter does not seem to fit properly, do not make modifications during installation as this may void your warranty. Call for assistance.

Verify the shifter length you have purchased is what you actually want. When installed, the bottom of the shifter lever will be approximately 4" above the tail housing bolts. From that point up to the top of the knob is how the shifter length is determined.

Before attempting to make any adjustments, the Shifter must be installed on the transmission and the transmission should be installed into the vehicle.

The Shifter is designed to lock in Park and in Neutral. You must depress the release button in the top of the shifter knob in order to shift out of Park or Neutral. The release button will only be flush with the top of the shift knob when the Shifter is in Park or Neutral.

To shift from Park directly to Drive (or Overdrive), depress the release button and hold it down while moving the shifter lever, and the Shifter will automatically stop in the Drive (or Overdrive) position. Once you release the button, then the Shifter will allow you to move the lever into the next lower gear. You must depress the button again to shift down again.

GM Tailmount Automatic Transmission Shifter Installation Instructions

Building American Quality... With A Lifetime Warranty!®

TOLL FREE 1-877-469-7440 • tech@lokar.com • www.lokar.com

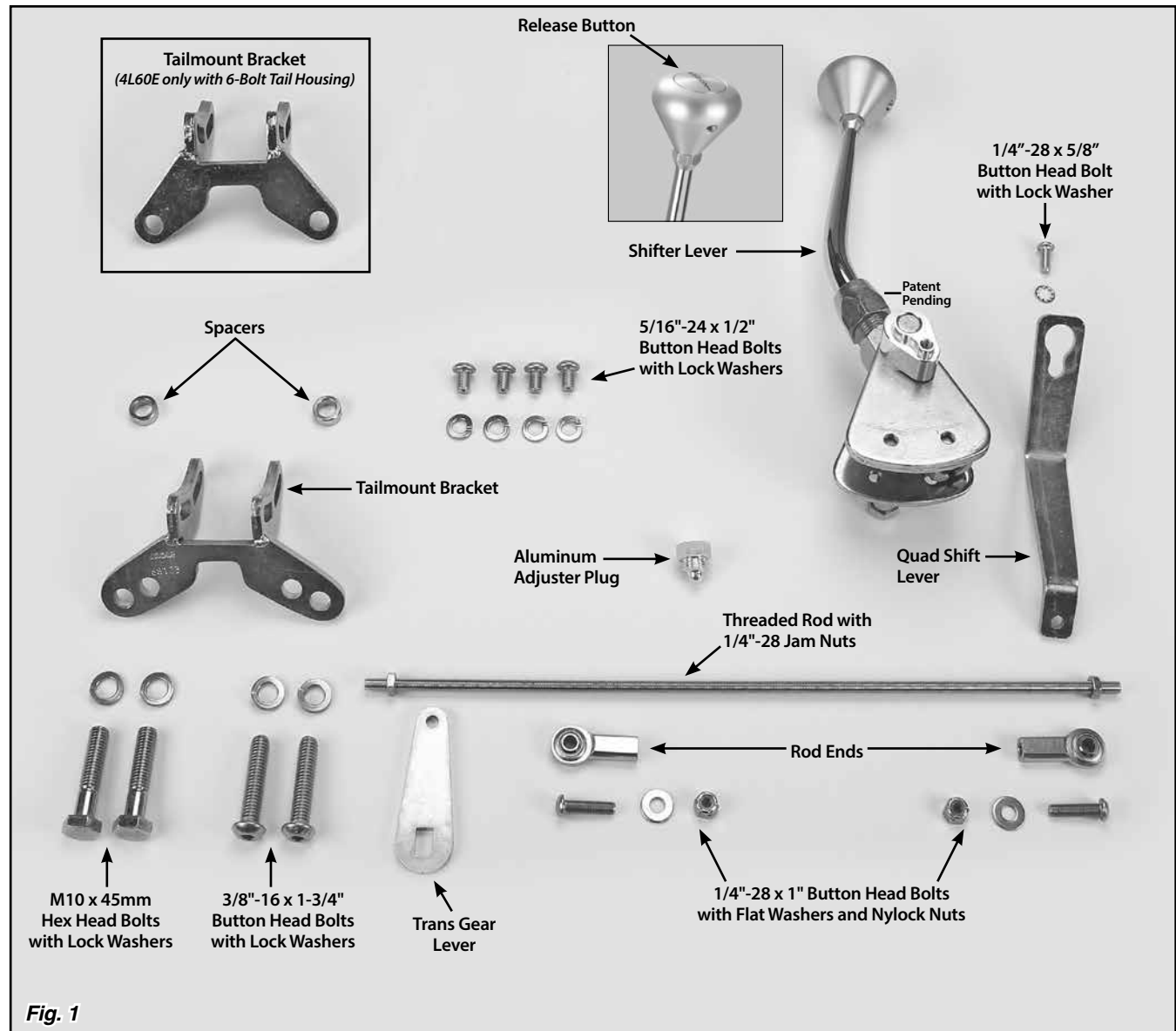

Fig. 1

These instructions assume you have full access to the transmission when beginning the installation, with the transmission removed from the vehicle or the vehicle body removed from the chassis.

Step 1: If your vehicle already has a shifter of any type installed, disconnect all shifter linkage and remove the shifter and its related hardware (neutral safety switch, back-up light switch, etc.).

Step 2: The tailmount bracket can be mounted onto the tail housing in two different positions. It can be mounted with the welded banana brackets pointing forward or rearward. These two positions give the Shifter approximately a 2" difference from front to back. **Fig. 2**

Determine which position will work the best for your particular application.

Step 3: Remove the top two tail housing bolts from your transmission. The Lokar Shifter includes four tail housing bolts with matching lock washers and two spacers. The button head bolts are SAE thread, and the hex head bolts are metric. Determine which pair of bolts (SAE or metric) match the thread on the bolts you removed from your transmission, and discard the other two bolts and matching lock washers.

Install the lock washers onto the bolts, and insert the bolts into the rear side of the tailmount bracket. Slide the spacers onto the bolts, and install the tailmount bracket onto your transmission, with the spacers between the tailmount bracket and the transmission. **Fig. 2**

Step 4: Insert the shifter assembly into the tailmount bracket so the bolt holes line up with the curved, slotted holes in the welded banana brackets, and install the 5/16"-24 x 1/2" button head bolts and lock washers. **Fig. 3**

Step 5: If you do not already have an opening in the floor in the correct location for the shifter, measure the distance from the front of the transmission to the center of the shifter. Transfer that measurement to the vehicle and cut the shifter opening in the floor. If you are using a Lokar shifter boot, the maximum opening for a round boot is 4" in diameter, and the maximum opening for a rectangular boot is 4" wide by 5-1/2" long.

Before proceeding any further, the transmission should be installed in the vehicle, with the vehicle body, driver's seat and dashboard in place.

Step 6: Make sure the two 5/16"-24 x 1/2" button head bolts and lock washers in the driver side of the shifter assembly on the welded banana bracket are tight. Move the Shifter through all the gear positions. Make sure the shifter lever and knob do not come in contact with the dash or the seat. The shifter assembly can be tilted forward or backward if needed by loosening the 5/16"-24 x 1/2" button head bolts and lock washers in the welded banana bracket on the driver side. Be sure to re-tighten the bolts and lock washers in the welded banana bracket after adjusting the angle of the shifter assembly.

If you disassemble the shifter assembly later, make sure the 5/16"-24 x 1/2" button head bolts and lock washers are put back into the curved, slotted holes in the welded banana brackets. Installing longer bolts will prevent the shifter from operating.

NOTE: If after installation you find the shape or length of the shifter lever is not suitable for your application, Lokar has a number of different styles and lengths of Shifter Lever Replacement Kits available for purchase separately through our dealer network.

Step 7: Make sure the Shifter is in the Park position. Temporarily place the quad shift lever in position on the quad lever bushing. It will need to be pointing to about the 4:30 – 5:00 position. If it is not, loosen the set screw in the top of the quad lever bushing with a 1/8" Allen wrench and slide the quad lever bushing off of the shaft. Reposition it on the shaft at approximately the 4:30 – 5:00 position, and retighten the set screw. **Fig. 4**

Step 8: Place the quad shift lever onto the quad lever bushing and secure using the 1/4"-28 x 5/8" button head bolt and lock washer.

Step 9: Install the trans gear lever onto the transmission and secure with your original nut. Place the trans gear lever in the Park position with the top of the lever pointing up and slightly towards the rear of the transmission, at about the 1:00 position. **Fig. 5**

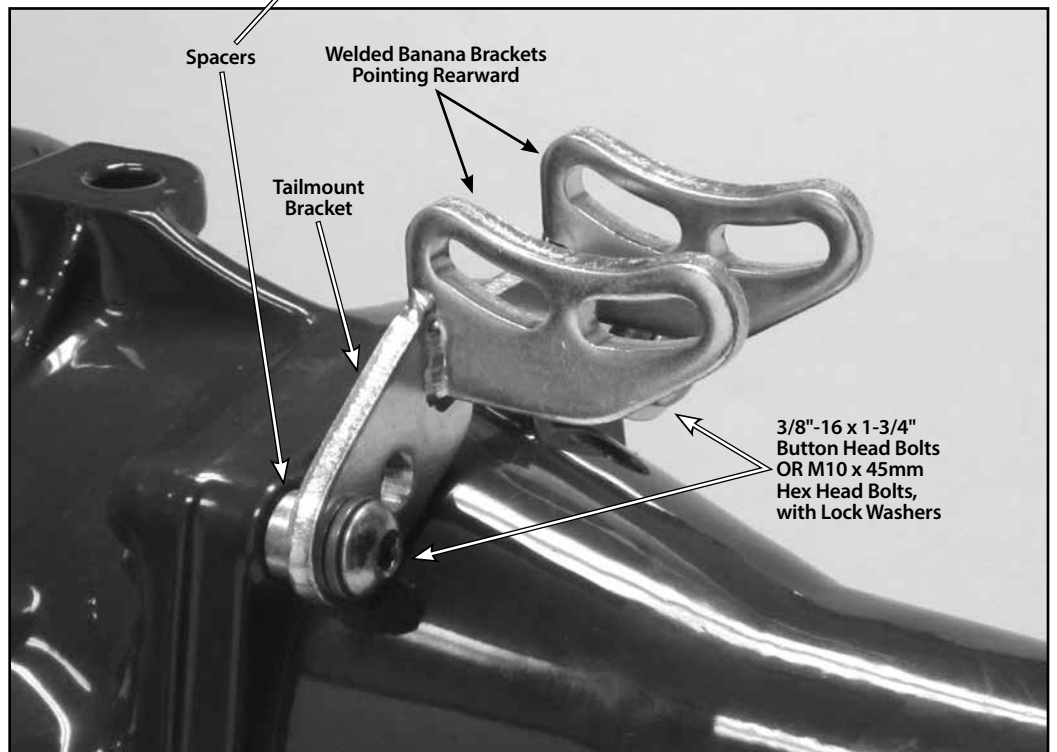
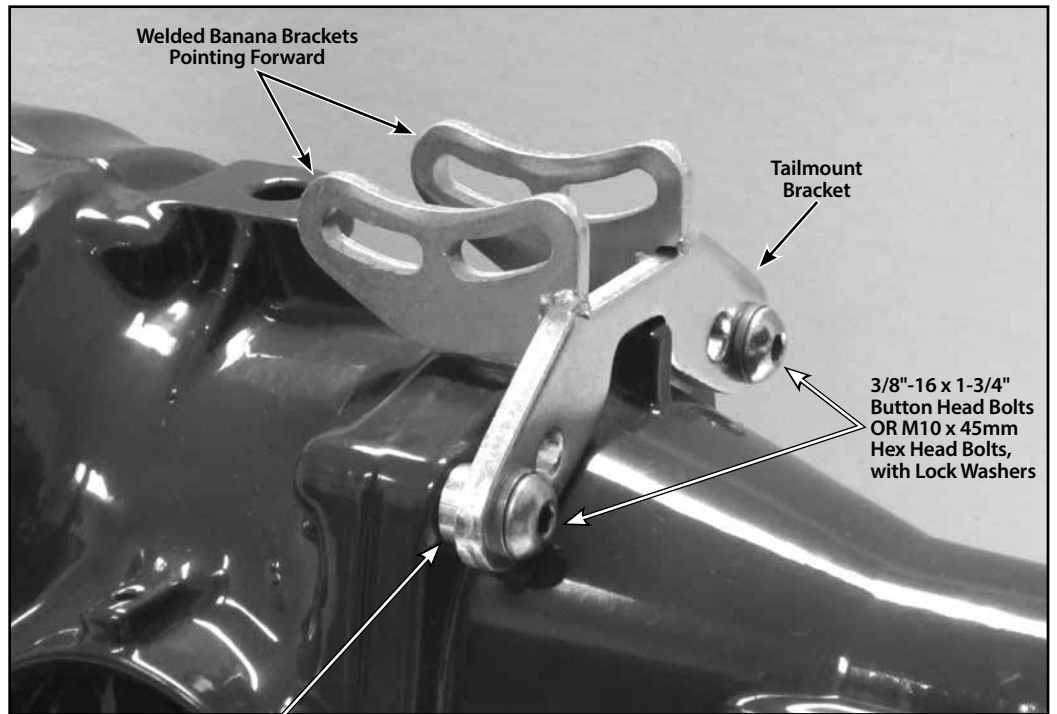

Fig. 2

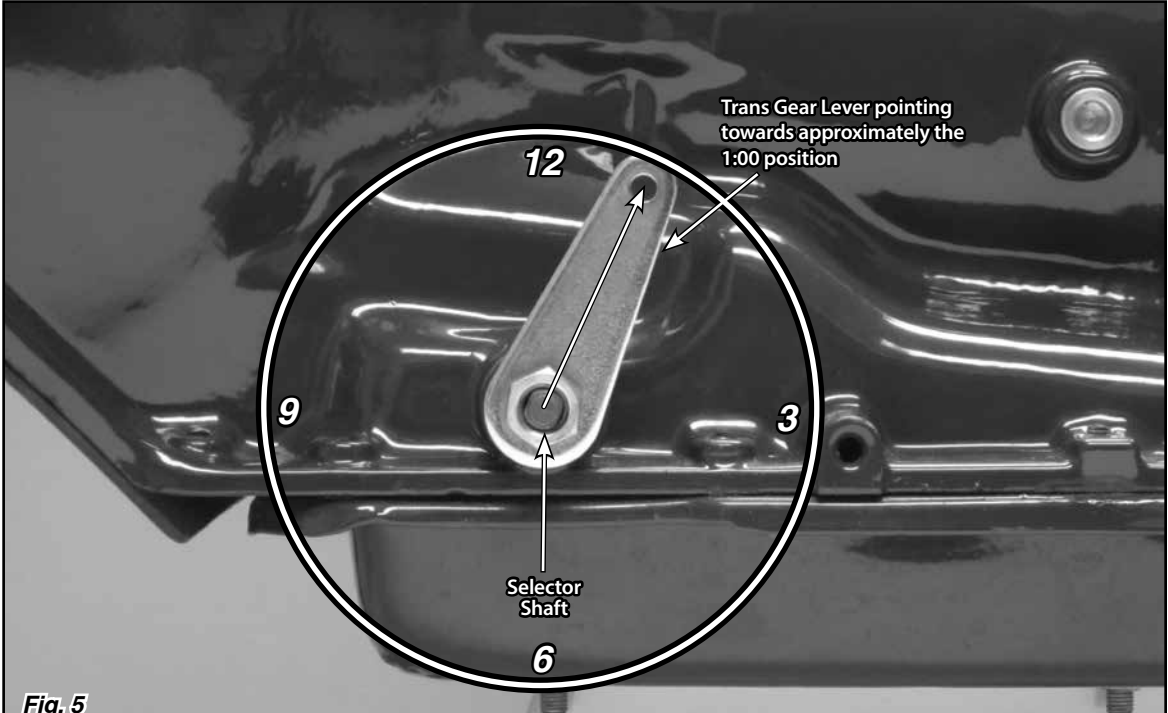
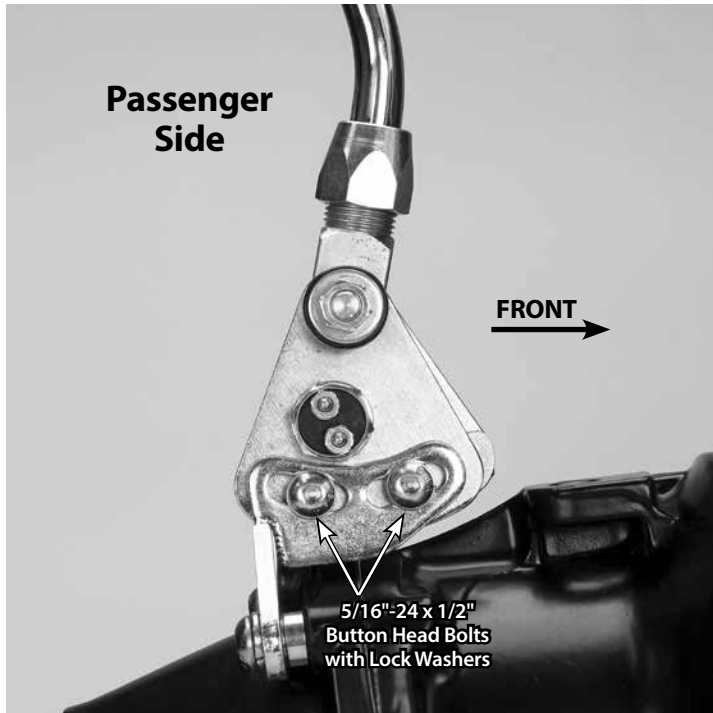
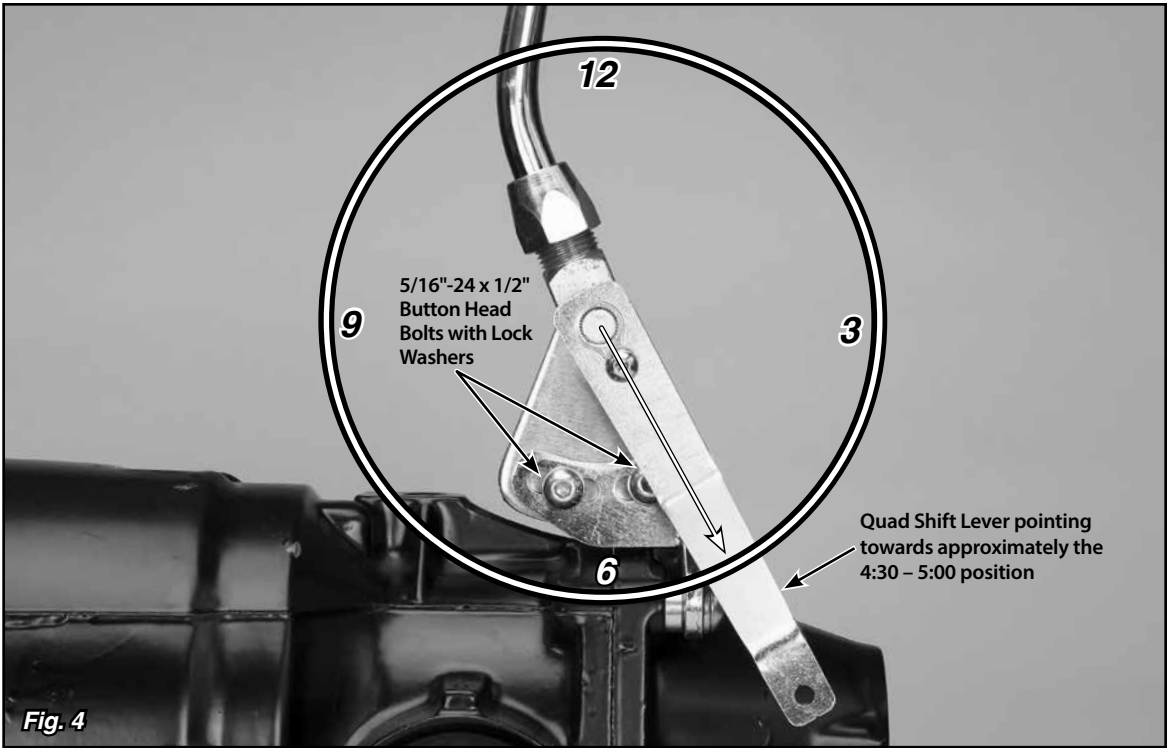
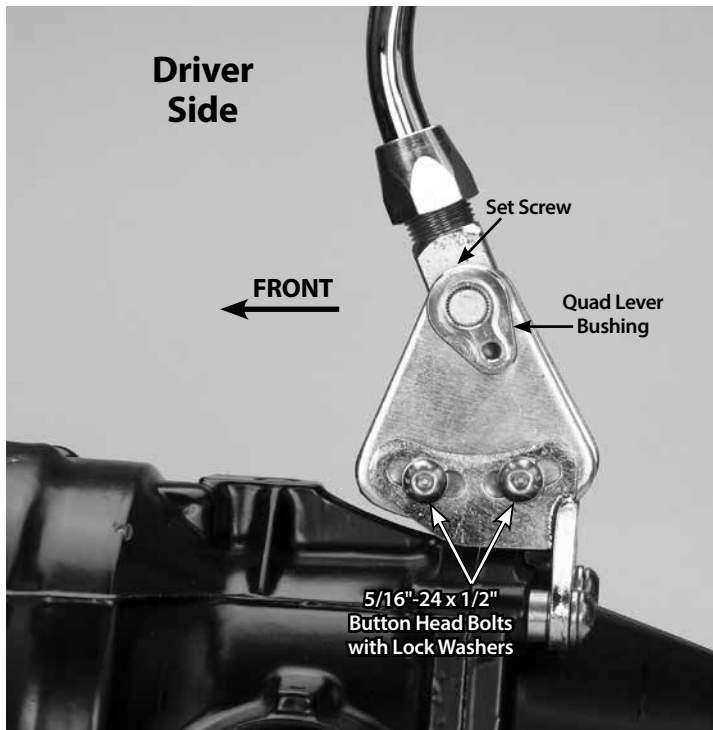

Fig. 3

Fig. 4

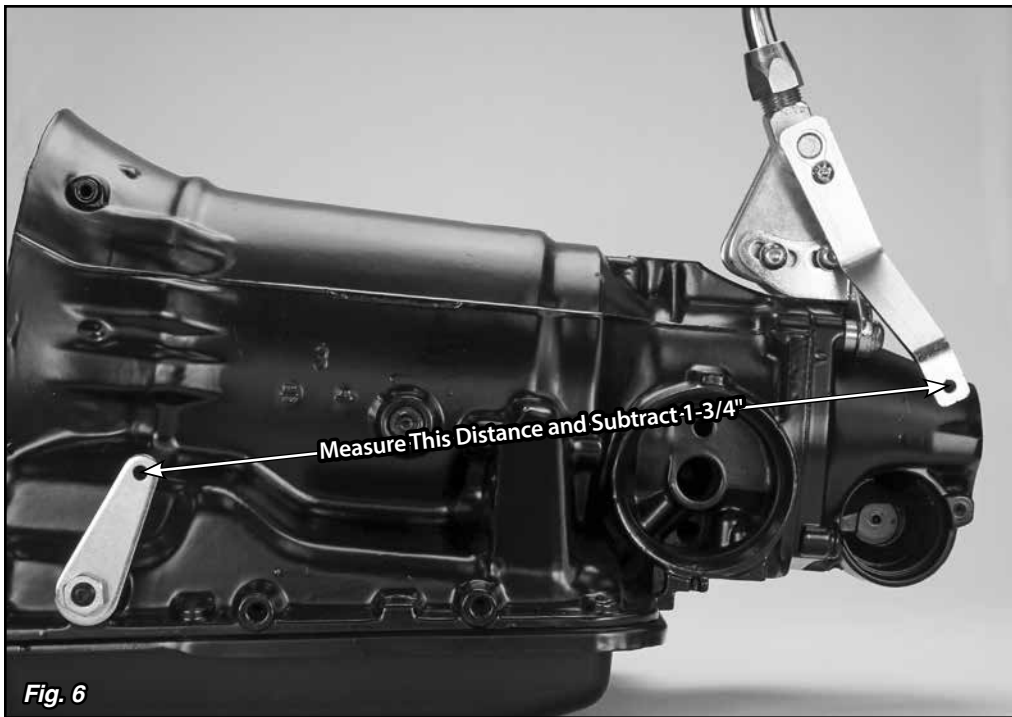

Fig. 6

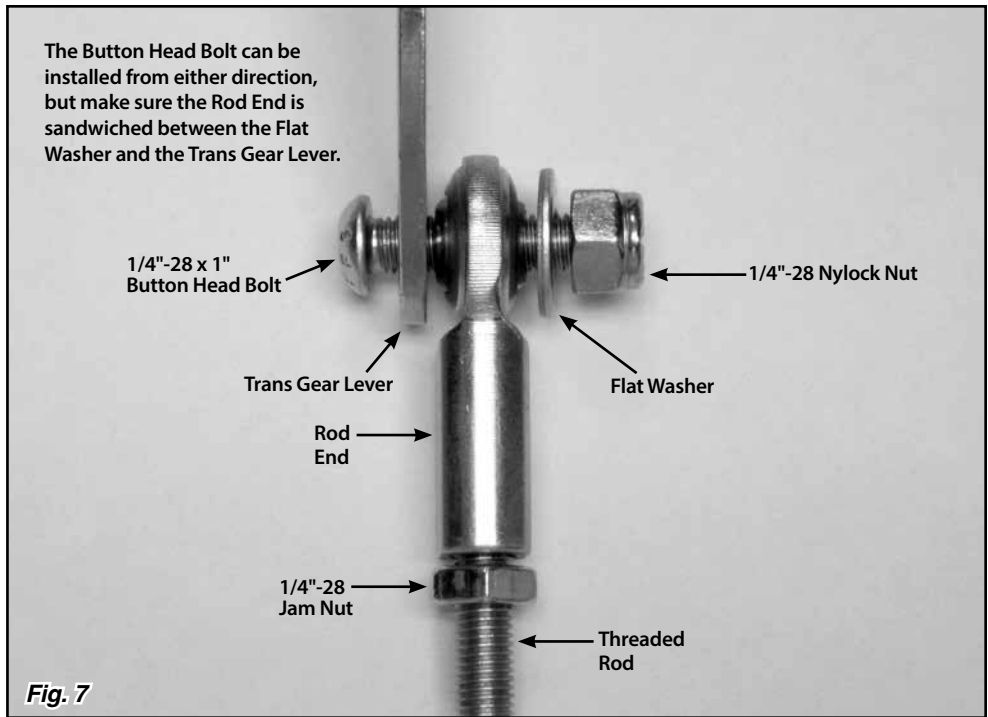

Fig. 7

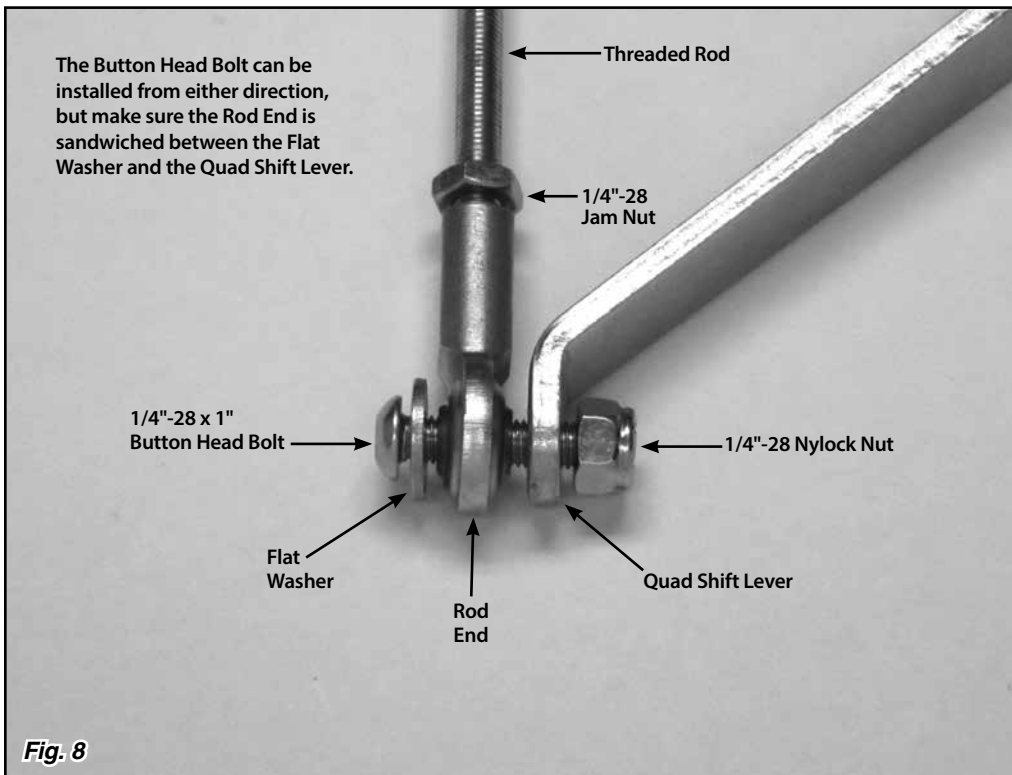

Fig. 8

Step 10: The threaded rod will connect the quad shift lever to the trans gear lever. Check to make sure nothing will interfere with the travel of the threaded rod.

If there is any interference, the threaded rod can be bent slightly as needed.

Verify both the Shifter and the transmission are in the Park position. Measure center-to-center between the 1/4" holes in the trans gear lever on the transmission and the quad shift lever on the Shifter. Subtract 1-3/4". **Fig. 6** This is the length you will cut the threaded rod to. Use a hacksaw or cutoff wheel to shorten the threaded rod, and deburr the cut end.

Step 11: Make sure a jam nut is still present on each end of the threaded rod, and install a rod end onto each end of the threaded rod. Attach the threaded rod assembly to the **inside** of the trans gear lever and to the **outside** of the quad shift lever using the 1/4"-28 x 1" button head bolts, flat washers, and nylock nuts as shown in **Fig. 7** and **Fig. 8**. The button head bolts can be installed from either direction, but make sure the rod end is sandwiched between the flat washer and the trans gear lever or quad shift lever.

Step 12: Check the adjustment of the threaded rod with the Shifter all the way forward in the Park position. Make sure the release button still moves up and down freely. The release button should be flush with the top of the knob in Park and Neutral. In the Reverse position, you cannot pull the lever back into Neutral without depressing the release button.

While the Shifter is in the Park position, make sure the transmission is firmly in the "Park" detent, with no tension on the threaded rod. You can verify this by removing the 1/4"-28 x 1" button head bolt with nylock nut that attaches the rod end to the quad shift lever or trans gear lever. Make sure the hole in the rod end exactly aligns with the hole in the quad shift lever or trans gear lever. The bolt should pass freely through both holes at the same time without binding. Do not force the holes to line up.

If the holes are not aligned, screw the rod end in or out just enough to be able to slide the bolt in and out without putting tension on the threaded rod. Make sure the quad shift lever and trans gear lever do not move during the adjustment procedure. Use this adjustment routine until the bolt will pass freely in and out of both the rod end and the quad shift lever or trans gear lever. Reinstall the 1/4"-28 nylock nut and the flat washer onto the bolt and tighten.

Once you have the Shifter adjusted correctly, tighten the jam nuts on the threaded rod. **Fig. 9**

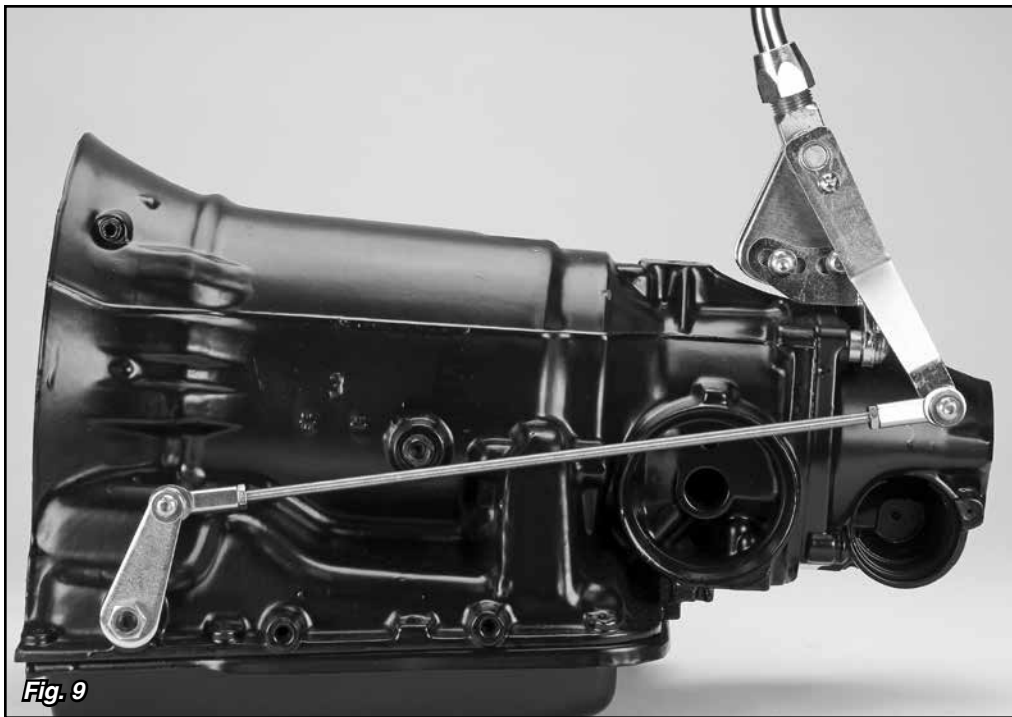

Fig. 9

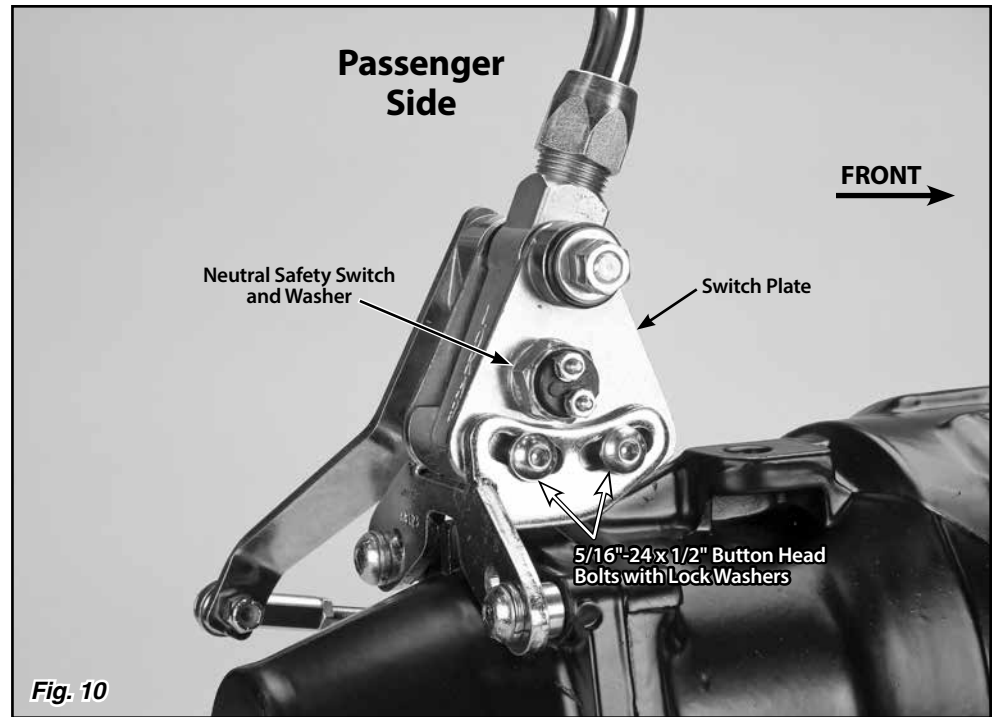

Fig. 10

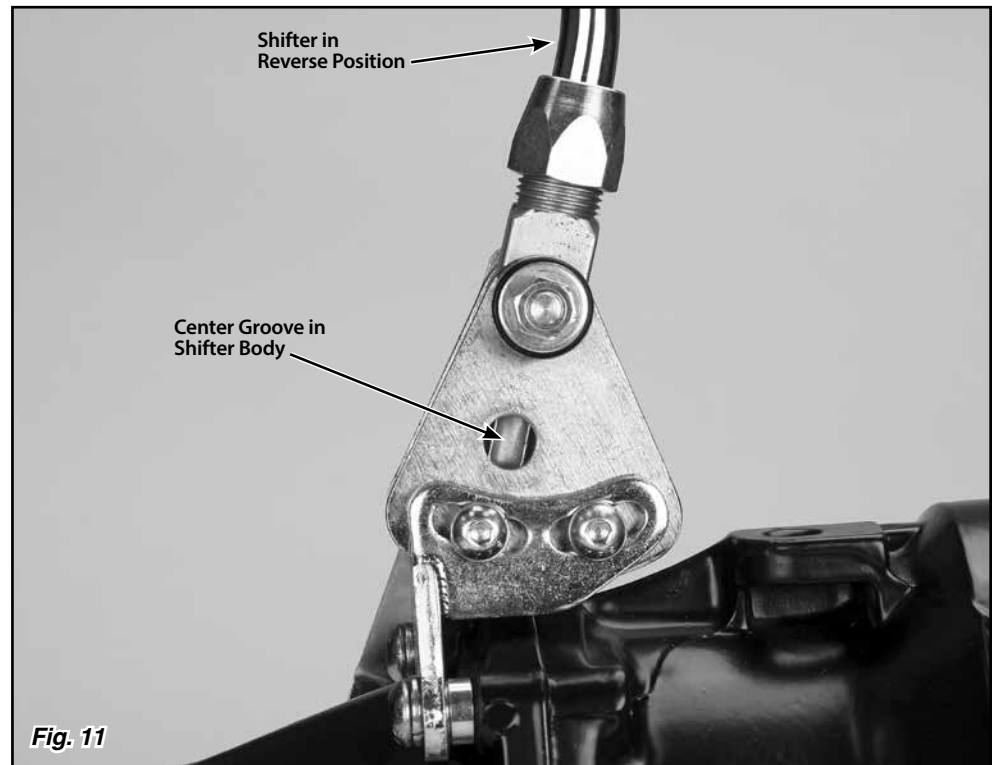

Fig. 11

Neutral Safety Switch Adjustment and Wiring

Step 13: For the neutral safety switch to function properly, the shifter linkage must be adjusted correctly. Do not attempt to adjust the neutral safety switch unless you have completed **Step 12**.

The Lokar Neutral Safety Switch is a simple on/off, non-directional switch. The switch passes current (turns on) when the ball is pushed in. It does not pass current (turns off) when the ball is out at its at-rest position.

Double check to make sure the bolts in the **driver** side welded banana bracket are tight.

Step 14: Remove the neutral safety switch and washer (**Fig. 10**) from the passenger side of the Shifter using a 7/8" wrench or socket.

Step 15: Loosen, but do not remove, the two 5/16"-24 x 1/2" button head bolts that connect the passenger side welded banana bracket to the switch plate (the bolts are in curved, slotted holes). **Fig. 10**

WARNING: Before taking the Shifter out of Park, be sure the vehicle's tires are blocked and the parking brake is set to avoid movement of the vehicle.

Step 16: Put the Shifter into the Reverse position. Reposition the switch plate so the hole in the switch plate lines up with the center groove in the shifter body. **Fig. 11** Screw the provided aluminum adjuster plug into the neutral safety switch opening. Moving the switch plate slightly forward and back while you are screwing the aluminum adjuster plug in will help get the shifter body centered on the adjuster plug. **Fig. 12**

Step 17: Retighten the two 5/16"-24 x 1/2" button head bolts that connect the passenger side welded banana bracket to the switch plate.

Step 18: Remove the aluminum adjuster plug, and reinstall the neutral safety switch and washer onto the Shifter. Test for continuity by connecting an ohmmeter lead to each stud on the neutral safety switch. When adjusted correctly, you will only have continuity between the two switch studs when the Shifter is in Park or Neutral. Continuity in any other gear requires readjustment of the neutral safety switch or the shifter linkage.

Step 19: Connect the neutral safety switch between your ignition switch and starter circuits. Check the wiring of your fuse panel:

- If there are (2) connections for a neutral safety switch, route a #12 (or heavier) stranded wire from these terminals in your fuse panel to the (2) terminals on the neutral safety switch. That completes the neutral safety switch wiring.
- If your fuse panel does not have neutral safety switch connections, locate the wire going from the ignition switch to the starter. If GM color codes are used, this wire will usually be purple. After locating the wire, disconnect it from the starter. It must be cut and routed from the ignition switch to one of the neutral safety switch terminals, and from the other neutral safety switch terminal to the same stud on the starter where the original wire was removed. If the wire must be lengthened, be sure to use wire at least the same size or larger than the original.

Step 20: Reconnect the negative battery cable and check operation. Make sure the engine will not start in Reverse or a drive gear. If it does, follow the neutral safety switch adjustment procedure again. **If your car should ever start in any gear other than Park or Neutral, please readjust the neutral safety switch.** Tighten all brackets and bolts correctly and securely and there should be no movement or maladjustment. If you have any questions after following this procedure, please call Lokar Technical Support.

Step 21: Once the installation is completely finished and the neutral safety switch is adjusted, remove each of the 5/16"-24 x 1/2" button head bolts from the welded banana brackets one at a time, apply blue thread locking compound to the threads, and reinstall the bolts with the lock washers.

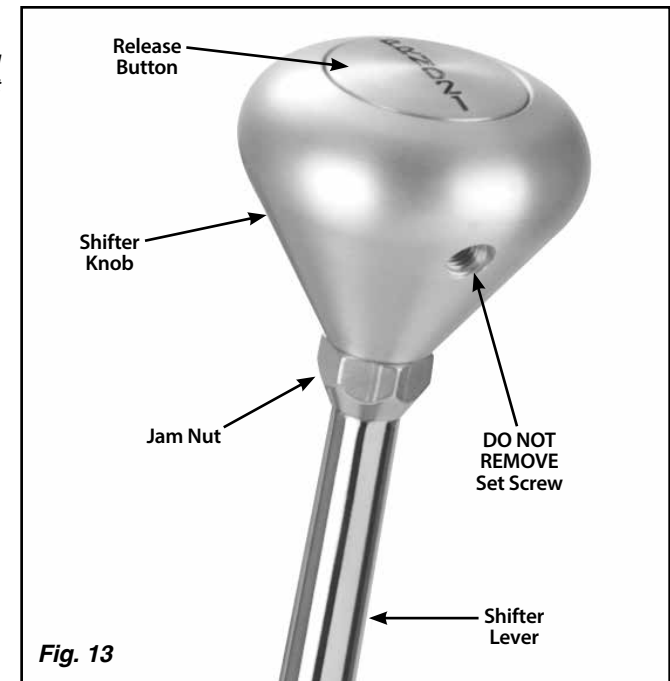
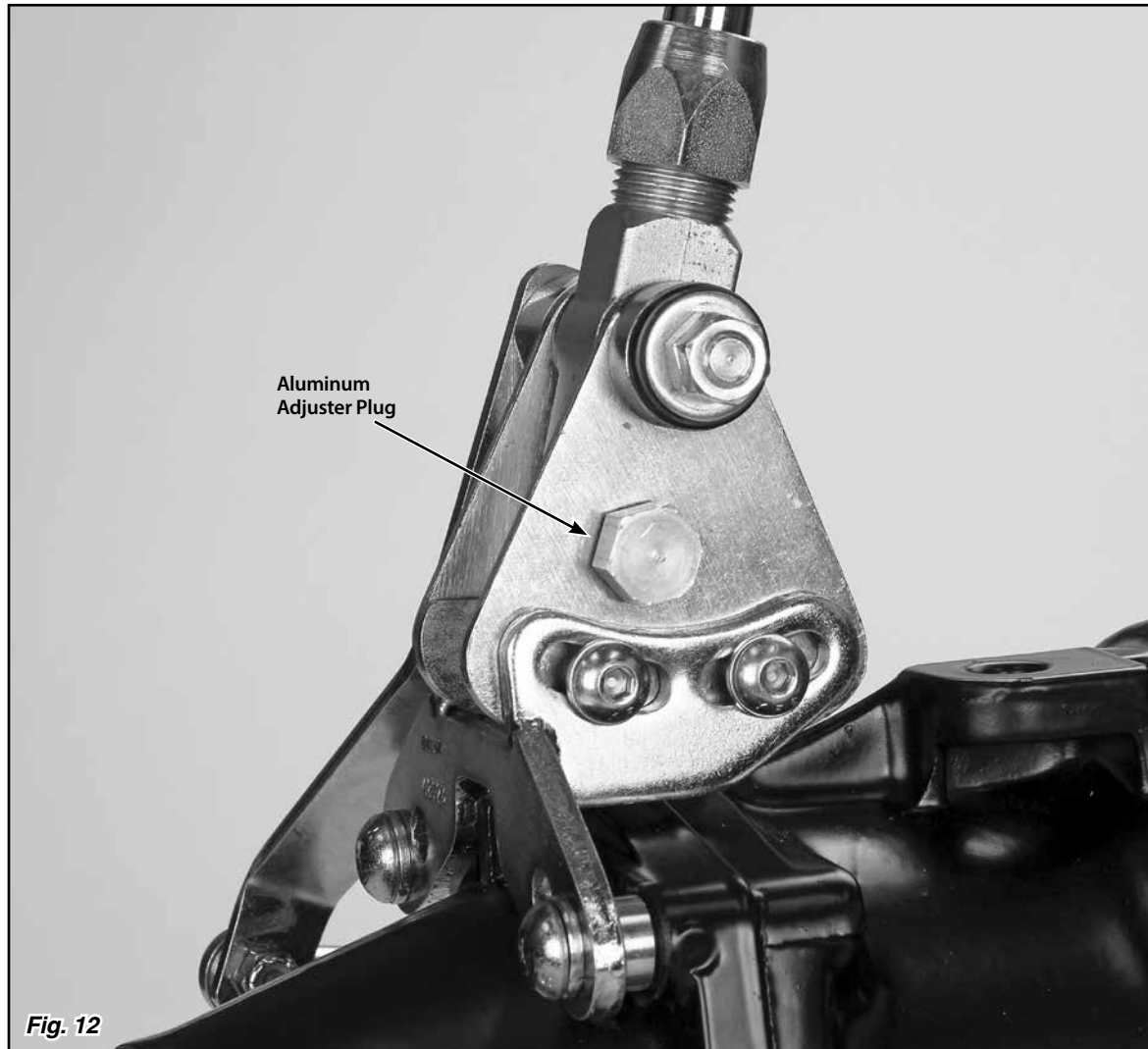

Lokar Shifter Knob Removal Instructions (For Shifters Manufactured 1995 and Later)

For Shifters manufactured 1994 and earlier, please contact Lokar for assistance.

To Remove the Shifter Knob:

- Step 1:** Make sure the Shifter is all the way forward in the Park position.
- Step 2:** Loosen the jam nut below the shifter knob. **DO NOT** loosen or remove the set screw that is in the knob. **Fig. 13**
- Step 3:** Turn the shifter knob counter-clockwise to remove.

To Install the Shifter Knob:

- Step 1:** Make sure the jam nut is still in place on the shifter lever.
- Step 2:** Screw the shifter knob onto the shifter lever until the release button comes up flush with the top of the shifter knob.
- Step 3:** Tighten the jam nut up against the bottom of the shifter knob.
- Step 4:** Check to make sure depressing the release button allows the shifter lever to be moved, and that the shifter lever still locks in Park and Neutral. If the Shifter will not come out of Park with the release button fully depressed, tighten the knob one turn and check it again. If the Shifter does not lock in Park, loosen the knob one turn and check it again.