

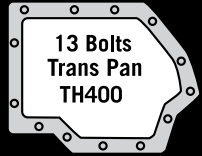

QUALITY... PLAIN & SIMPLE®

TH400 Automatic Trans Mount Shifter Installation Instructions

TH400 Automatic Trans Mount Shifter Installation Instructions



Building American Quality... With A Lifetime Warranty!®

TOLL FREE 1-877-469-7440 • tech@lokar.com • www.lokar.com

General Installation Notes:

Please read these instructions completely before beginning the installation. If you have any questions please call.

Before beginning the installation, disconnect the negative battery cable and use wheel chocks to block the vehicle's wheels.

Make sure the engine, transmission, body and frame are properly grounded. We recommend using anti-seize lubricant on all aluminum threads.

Refer to Fig. 1 for the component names.

Tools and Materials Required:

- Standard Allen wrenches: 1/8", 5/32", 3/16", 7/32"
- Wrench or Socket Sizes: 5/16", 3/8", 7/16", 1/2", 9/16", 5/8", 7/8"
- Tape Measure
- Metal cutting tool, such as a hacksaw or a die grinder with a cut-off wheel
- Ohmmeter
- Wire cutters/strippers
- Wire crimping or soldering tools
- Blue thread locking compound

Lokar Shifters are designed to fit specific transmissions. Before installing the Shifter, verify that you have the proper model for your transmission. If your Shifter does not seem to fit properly, do not make modifications during installation as this may void your warranty. Call for assistance.

Verify that the Shifter length you have purchased is what you actually want. When installed, the bottom of the shifter lever will be approximately 3-1/2" - 4" above the transmission case. From that point up to the top of the knob is how the Shifter length is determined.

Before attempting to make any adjustments, the Shifter must be installed on the transmission and the transmission should be installed into the vehicle.

The Shifter is designed to lock in Park and in Neutral. You must depress the release button in the top of the shifter knob in order to shift out of Park or Neutral. The release button will only be flush with the top of the knob when the Shifter is in Park or Neutral.

To shift from Park directly to Drive, depress the release button and hold it down while moving the shifter lever, and the Shifter will automatically stop in the Drive position. Once you release the button, the Shifter will allow you to move the lever into 2nd gear. You must depress the button again to shift down into 1st gear.

These instructions assume that you have full access to the transmission when the Shifter installation is begun, with the transmission removed from the vehicle, or the vehicle body removed from the chassis.

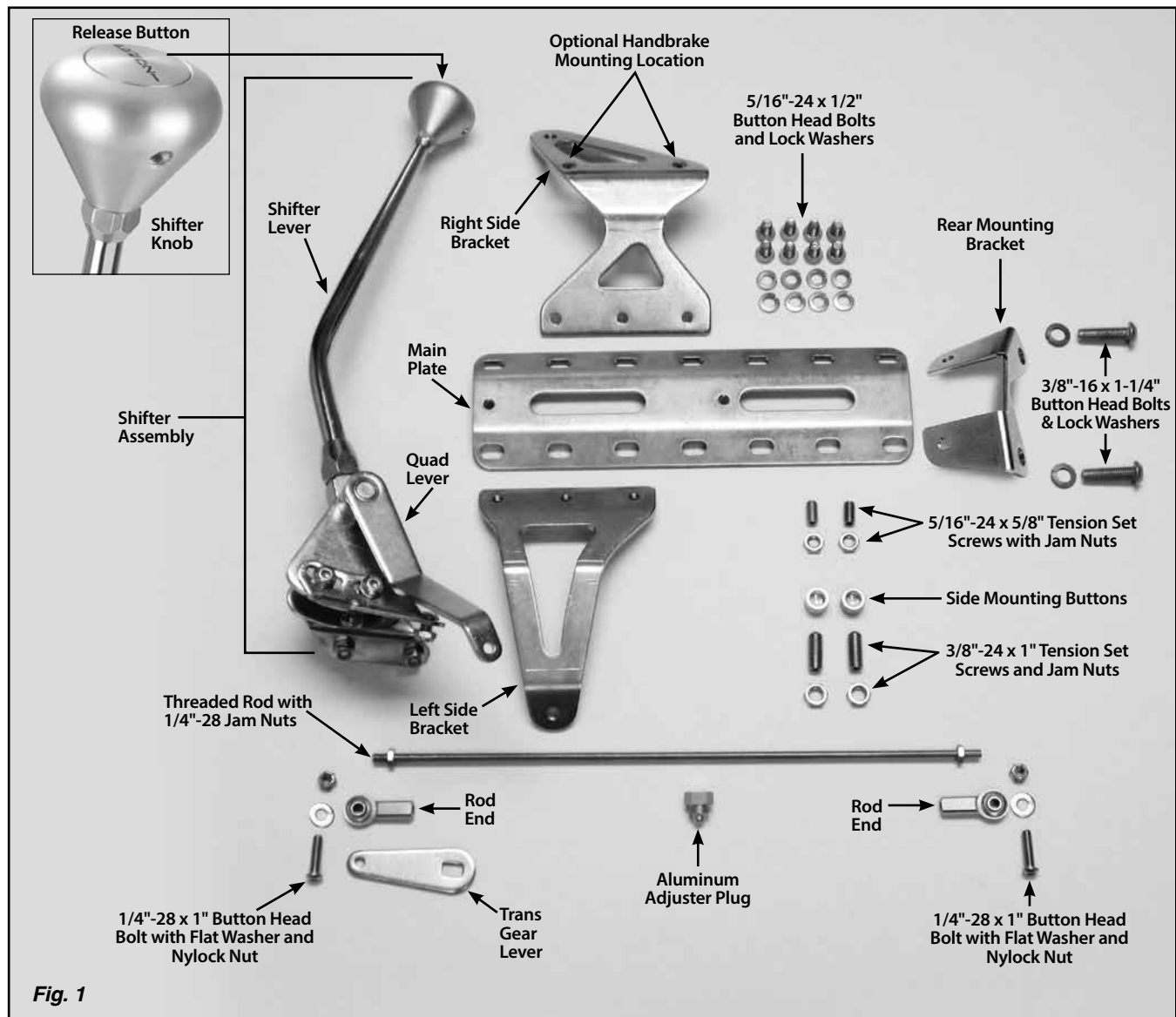
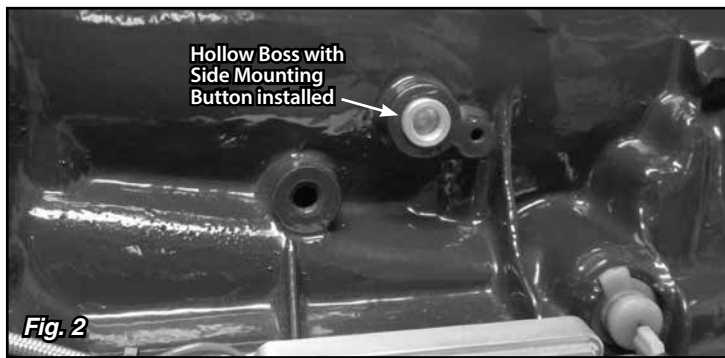

Fig. 1



Hollow Boss with Side Mounting Button Installed

Fig. 2

Step 1: If your vehicle already has a shifter of any type installed, disconnect all shifter linkage and remove the shifter and its related hardware (neutral safety switch, back-up light switch, etc.).

Step 2: In the Lokar Shifter kit you are supplied with two aluminum side mounting buttons that are approximately 5/8" in diameter. Your transmission has two round, hollow bosses cast into the case, one on the left side and one on the right side. Clean any paint or debris out of these bosses, and install the side mounting buttons into the bosses with the flat side in toward the transmission case. **Fig. 2**

Step 3: The main plate has two 5/16"-24 tension set screw holes. One set screw hole is in the center of the main plate, and the other set screw hole is at one end of the main plate. The main plate will be installed so that the end of the main plate that has a set screw hole will go to the front (towards the engine), and the end that does not have a set screw hole will go to the rear.

The left side bracket and right side bracket bolt directly to the main plate. **NOTE: The right side bracket will be offset rearward on the main plate by one slot, compared to the left side bracket.** Attach the side brackets to the underside of the main plate as shown in **Fig. 3**, using three 5/16"-24 x 1/2" button head bolts and lock washers on each side. **DO NOT TIGHTEN AT THIS TIME.**

Step 4: (2 Wheel Drive Transmissions) Attach the rear mounting bracket to the underside of the main plate with the bracket ears pointing to the front of the transmission (toward the engine) as shown in **Fig. 3**, using two 5/16"-24 x 1/2" button head bolts and lock washers. **DO NOT TIGHTEN AT THIS TIME.**

(4 Wheel Drive Transmissions) You will not be using the rear mounting bracket.

Step 5: (2 Wheel Drive Transmissions) Remove the top two tail housing bolts from the transmission. Install the mounting bracket assembly onto the transmission by first installing two 3/8"-16 x 1-1/4" button head bolts with lock washers through the rear mounting bracket and into the transmission at the tail housing. **Fig. 4**

(4 Wheel Drive Transmissions) Start the 5/16"-24 x 5/8" tension set screws into the tension set screw holes at the front and in the center of the shifter main plate. Set the mounting bracket assembly into place on top of the transmission. **Fig. 4**

Step 6: (All) Install the 3/8"-24 x 1" tension set screws through the side brackets into each side mounting button, but do not tighten.

Step 7: (All) Tighten all of the bolts on the left, right, and rear mounting brackets, leaving the tension set screws for last. Tighten the tension set screws on the side brackets until the side brackets move outwards about 1/8". On 4 wheel drive transmissions, tighten the set screws in the main plate last, threading them in until they contact the top of the transmission case (2 wheel drive transmissions do not require set screws in the main plate). Finally, install a 3/8"-24 jam nut onto the tension set screws on the side brackets and tighten.

(4 Wheel Drive Transmissions) Install and tighten the 5/16"-24 jam nuts on the set screws in the main plate.

Step 8: You are now ready to position your shifter assembly onto the main plate. There are several mounting position options from front to rear on the transmission.

If your vehicle already has a shifter opening in the tunnel and the engine is installed in the vehicle, measure from the rear face of the engine block to the center of your existing shifter opening. If your engine is not yet installed in the vehicle, measure from the engine mounts to the center of the existing shifter opening instead.

If the vehicle does not have an existing shifter opening in the transmission tunnel, decide where you want the Shifter to be positioned so that it will be comfortable and will not interfere with the dash or a bench seat (if applicable). Mark that spot on the tunnel, and measure as described above.

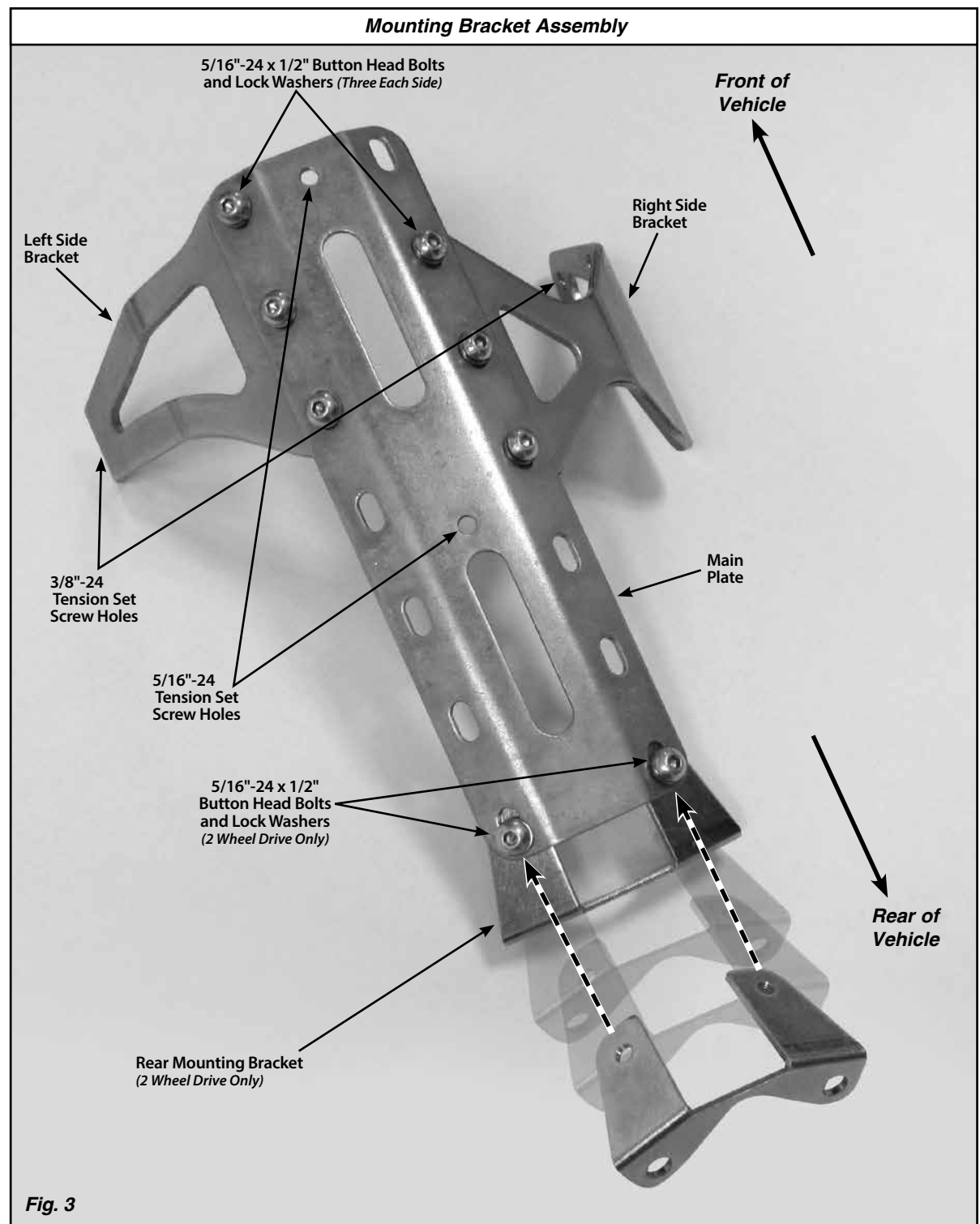

Fig. 3

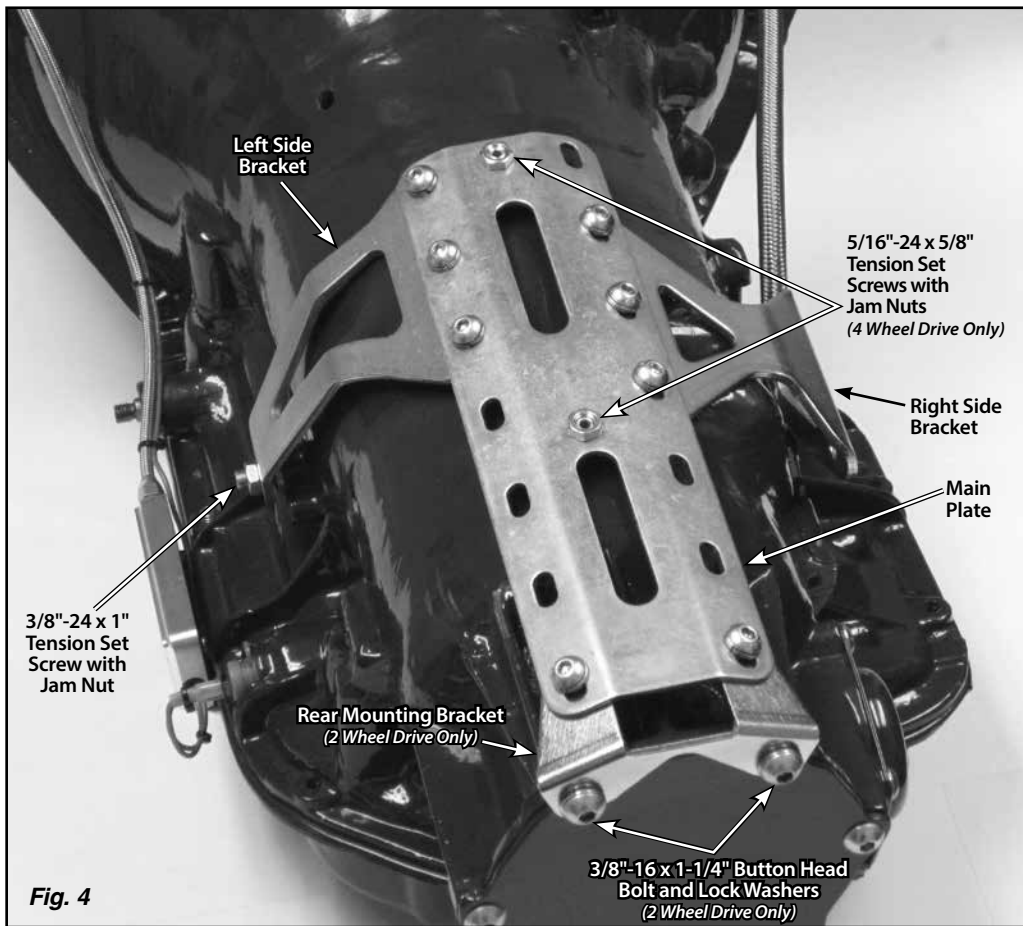

Fig. 4

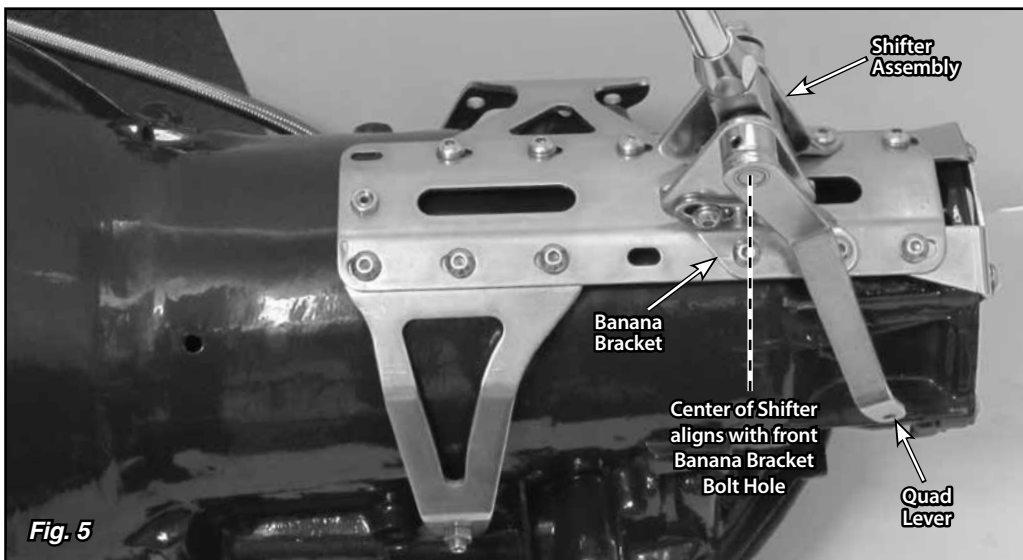

Fig. 5

Step 8: (Continued) Transfer that measurement to the transmission (or to the engine/transmission assembly if the engine is not installed in the vehicle). Mark that location on the Shifter's main plate. The holes in the main plate that are closest to your mark are where the **FRONT** banana bracket bolts will need to be installed. **Fig. 5**

If you choose to install the shifter assembly where any of its mounting holes line up with the left, right, or rear bracket mounting bolts, mount the shifter using the same bolts and lock washers that are already being used to attach the left, right, or rear mounting brackets to the main plate. In this case, the bolts will go through the banana bracket first, then the main plate, and finally into the mounting bracket below.

Any shifter mounting holes that do not line up with the side or rear mounting bracket bolts must use the provided 5/16"-24 x 1/2" button head bolts and nylock nuts (**NO lock washers**). Make sure the shifter assembly is mounted using all four bolt holes. **Do not use any other length bolts. Fig. 5**

Step 9: If your vehicle does not already have an existing shifter opening, cut the opening now. If you are using a Lokar Shifter Boot, the maximum opening for a round style is 4" in diameter, and the maximum opening for a rectangular style is 4" wide by 5-1/2" long.

Before proceeding any further, the transmission should be installed in the vehicle, with the vehicle body, driver's seat and dashboard in place.

Step 10: Make sure the two 5/16"-24 x 3/8" button head bolts that attach the left side banana bracket to the shifter assembly (in the curved, slotted holes) are tight. Before tightening the shifter assembly down to the main plate, move the shifter lever through all the gear positions. Make sure that the shifter lever and knob do not come in contact with the dash or the seat. The shifter assembly can be tilted forward or backward if needed by loosening the 5/16"-24 x 3/8" button head bolts in the curved, slotted holes in the left side banana bracket. **Fig. 6**

If you ever disassemble the shifter assembly, be sure that the 5/16"-24 x 3/8" button head bolts and lock washers are put back into the curved, slotted holes in the banana brackets. Installing longer bolts will prevent the Shifter from operating.

NOTE: If you find after installation that the shape or length of the shifter lever is not suitable for your application, Lokar has a number of different styles and lengths of Shifter Lever Replacement Kits available for purchase separately through our dealer network.

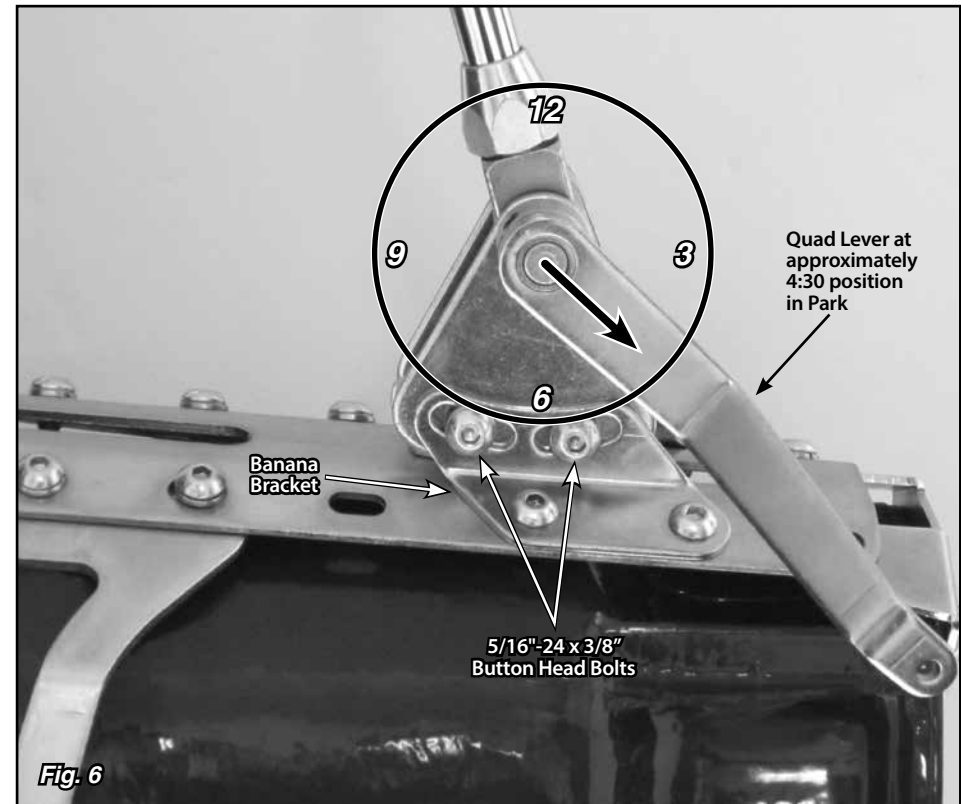

Fig. 6

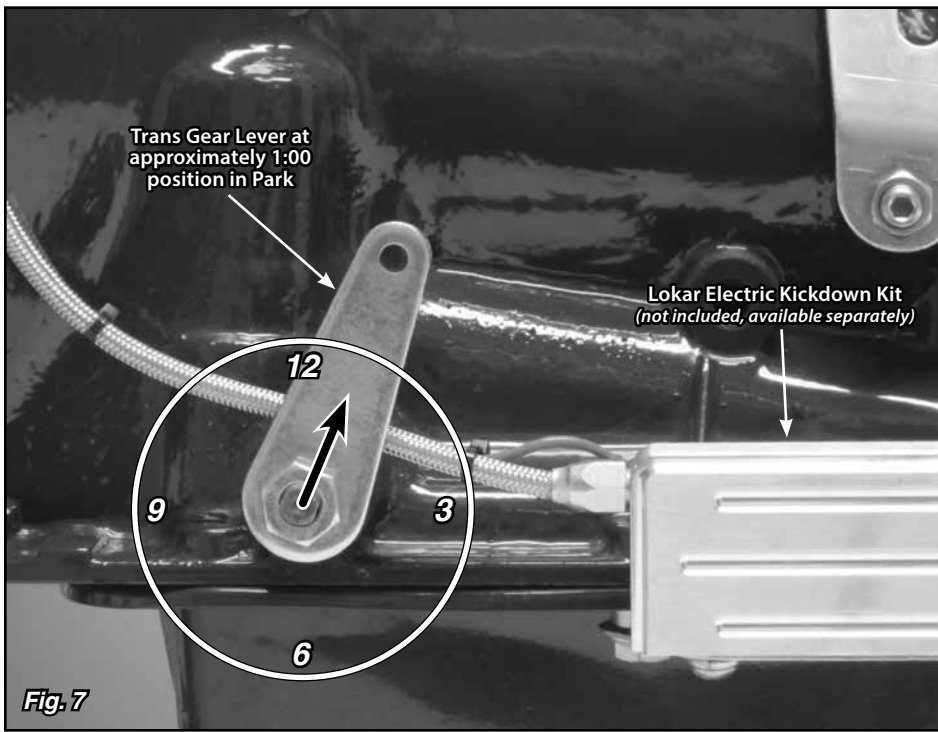

Fig. 7



Fig. 8

NOTE: The bolt can be installed from either side. Make sure the Rod End is sandwiched between the Flat Washer and the Trans Gear Lever.

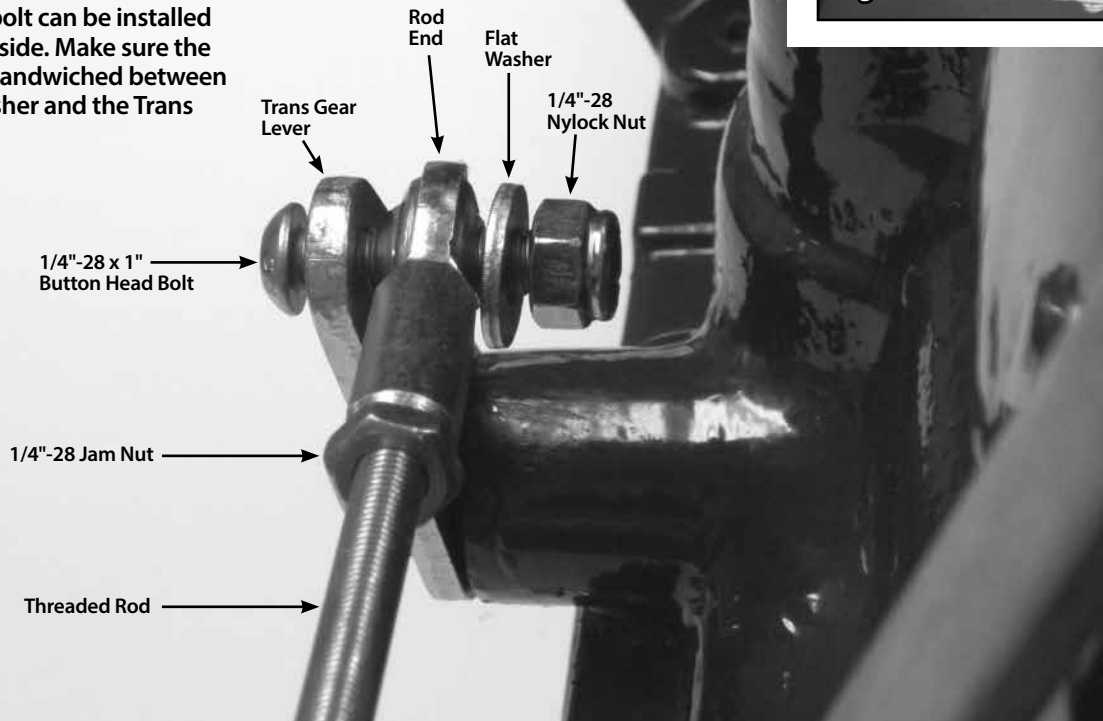

Fig. 9

Step 11: Put the shifter lever into the Park position and check the position of the quad lever. It will need to be pointing to about the 4:30 position. If it is not, loosen the set screw in the top of the quad lever with a 1/8" Allen wrench and slide the quad lever off of the shaft. Reposition it on the shaft at approximately the 4:30 position, and retighten the set screw. **Fig. 6**

NOTE: If your shifter assembly is placed near the front of the main plate, you may need to position the quad lever slightly higher, such as at the 4:00 position instead. This will help prevent over-centering the trans gear lever.

Step 12: Remove the rod end from the new trans gear lever. Install the trans gear lever onto the transmission and secure with your original nut. Place the trans gear lever in the Park position with the top of the lever pointing up and slightly towards the rear of the transmission, at about the 1:00 position. **Fig. 7**

Step 13: The threaded rod will connect the quad lever to the trans gear lever. Check to make sure that nothing will interfere with the travel of the threaded rod. If there is any interference, the threaded rod can be bent slightly as needed.

Verify that both the shifter lever and the transmission are in the Park position. Measure center-to-center between the 1/4" holes in the trans gear lever on the transmission and the quad lever on the shifter. Subtract 1-3/4". **Fig. 8** This is the length you will cut the threaded rod to. Use a hacksaw or cutoff wheel to shorten the threaded rod.

Step 14: Install a rod end onto each end of the threaded rod. Attach the threaded rod assembly to the **inside** of the trans gear lever and to the **outside** of the quad lever using the 1/4"-28 x 1" button head bolts, flat washers, and nylock nuts as shown in **Fig. 9** and **Fig. 10**. The button head bolts can be installed from either direction, but make sure the rod end is sandwiched between the flat washer and the quad lever or trans gear lever.

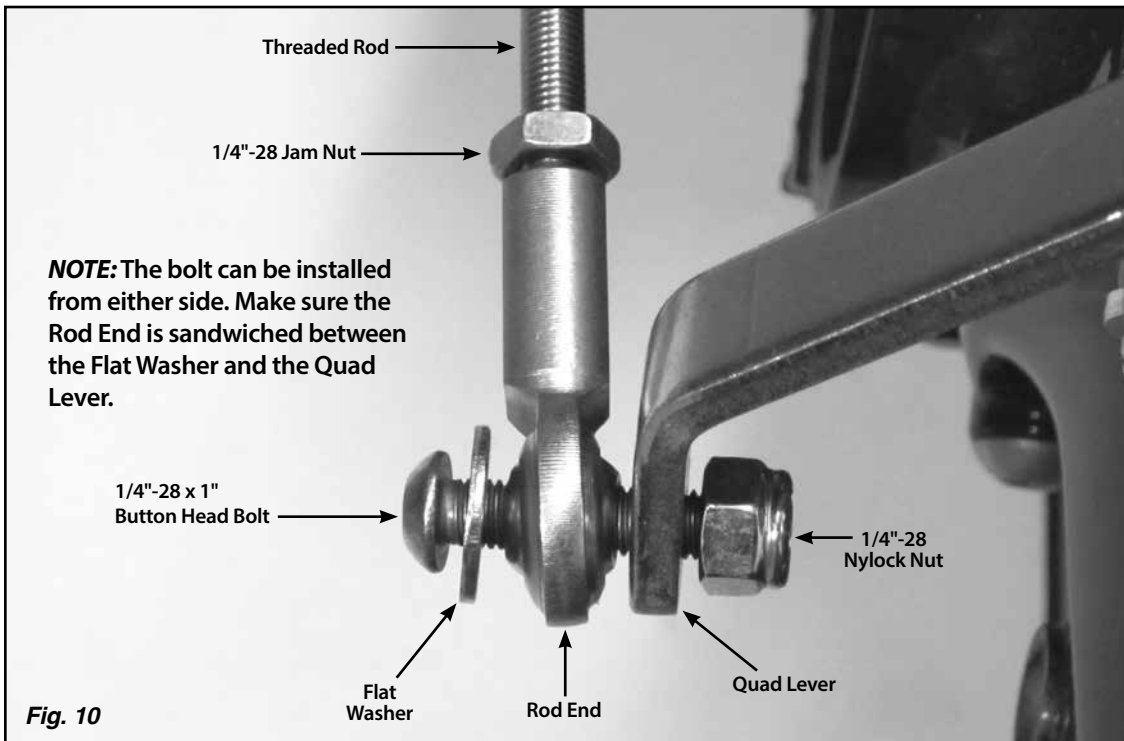

NOTE: The bolt can be installed from either side. Make sure the Rod End is sandwiched between the Flat Washer and the Quad Lever.

Fig. 10

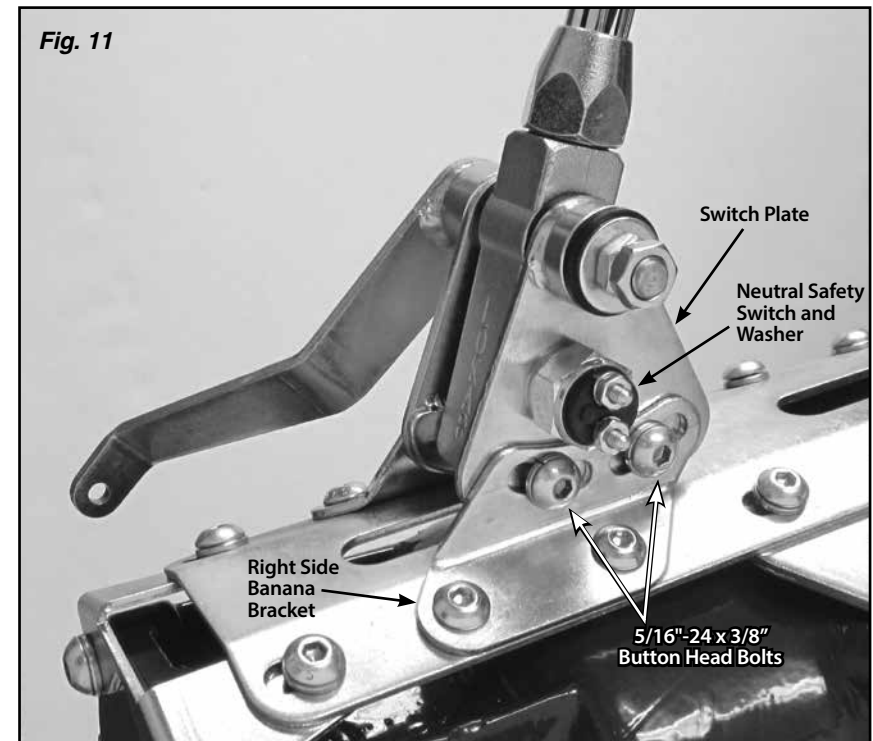

Fig. 11

Step 15: Check the adjustment of the Shifter by placing the shifter lever all the way forward into the Park position. Make sure that the release button still moves up and down freely. The release button should be flush with the knob in Park and Neutral. In the Reverse position, you cannot pull the shifter lever back into Neutral without depressing the release button.

While the shifter lever is in the Park position, make sure the transmission is firmly in the "Park" detent, with no tension on the threaded rod. You can verify this by removing the 1/4" x 1" button head bolt with nylock nut that attaches the rod end to the quad lever or trans gear lever at either end of the threaded rod. Make sure the hole in the rod end exactly aligns with the hole in the quad lever or trans gear lever. The bolt should pass freely through both holes at the same time without binding. Do not force the holes to line up.

If the holes are not aligned, screw the rod end in or out just enough to be able to slide the bolt in and out without putting tension on the threaded rod. Make sure that the quad lever and trans gear lever do not move during the adjustment procedure. Use this adjustment routine until the bolt will pass freely in and out of both the rod end and the quad lever or trans gear lever. Reinstall the 1/4"-28 nylock nut and the flat washer in its proper position onto the bolt, and tighten.

Once you have the Shifter adjusted correctly, tighten the jam nuts on the threaded rod.

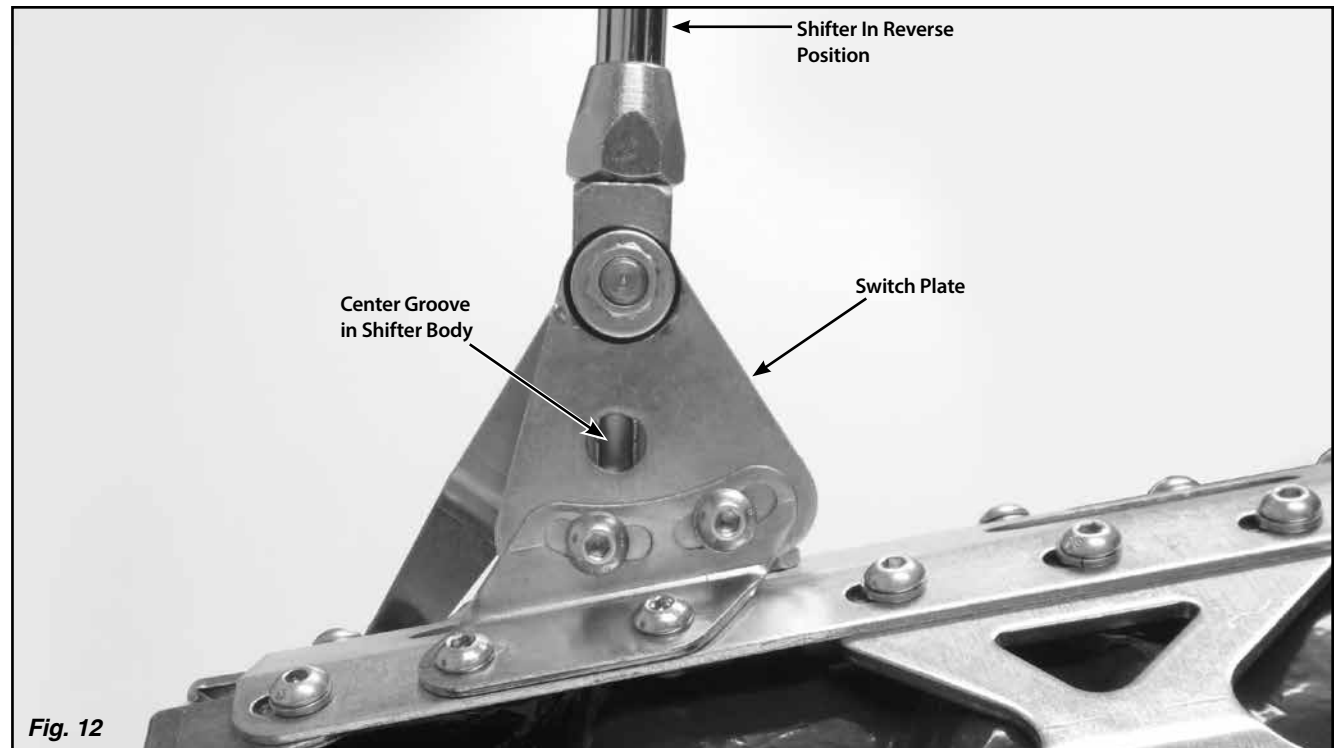

Fig. 12

Neutral Safety Switch Adjustment and Wiring

Step 16: For the neutral safety switch to function properly, the shifter linkage must be adjusted correctly. Do not attempt to adjust the neutral safety switch unless you have completed **Step 15**.

The Lokar Neutral Safety Switch is a simple on/off, non-directional switch. The switch passes current (turns on) when the ball is pushed in. It does not pass current (turns off) when the ball is out at its at-rest position.

Double check to make sure that the bolts connecting the left side banana bracket to the shifter assembly are tight. **Fig. 6**

Step 17: Remove the neutral safety switch and washer from the switch plate on the right side of the shifter assembly using a 7/8" wrench or socket. **Fig. 11**

Step 18: Loosen, but do not remove, the two 5/16"-24 x 3/8" button head bolts that attach the switch plate to the right side banana bracket (the bolts are in curved, slotted holes). **Fig. 11**

WARNING: Before taking the shifter lever out of Park, be sure that the vehicle's tires are blocked and the parking brake is set to avoid movement of the vehicle.

Step 19: Put the shifter lever into the Reverse position. Reposition the switch plate so that the hole in the switch plate lines up with the center groove in the shifter body. **Fig. 12** Screw the provided aluminum adjuster plug into the neutral safety switch opening. Wiggling the switch plate slightly forward and back while you are screwing the aluminum adjuster plug in will help get the shifter body centered on the adjuster plug. **Fig. 13**

Step 20: Retighten the two 5/16"-24 x 3/8" button head bolts that attach the right side banana bracket to the switch plate.

Step 21: Remove the aluminum adjuster plug, and reinstall the neutral safety switch and washer onto the shifter. Test for continuity by connecting an ohmmeter lead to each stud on the neutral safety switch. When adjusted correctly, you will only have continuity between the two switch studs when the shifter lever is in Park or Neutral. Continuity in any other gear requires readjustment of the neutral safety switch or the threaded rod.

Step 22: Connect the neutral safety switch between your ignition switch and starter circuits. Check the wiring of your fuse panel:

- **If there are (2) connections for a neutral safety switch**, run a #12 (or heavier) stranded wire from these terminals in your fuse panel to the (2) terminals on the neutral safety switch. That completes the Neutral Safety Switch wiring.
- **If your fuse panel does not have neutral safety switch connections**, locate the wire going from the ignition switch to the starter. If GM color codes are used, this wire will usually be purple. After locating the wire, disconnect it from the starter. It must be cut and routed from the ignition switch to one of the neutral safety switch terminals, and from the other neutral safety switch terminal to the same stud on the starter where the original wire was removed. If the wire must be lengthened, be sure to use wire that is at least the same size or larger than the original.

Step 23: Reconnect the negative battery cable and check operation. Make sure that the engine will not start in reverse or a drive gear. If it does, follow the neutral safety switch adjustment procedure again. If your vehicle should ever start in any gear other than Park or Neutral, please readjust the neutral safety switch accordingly. Tighten all brackets and bolts correctly and securely and there should be no movement or maladjustment. If you have any questions after following this procedure, please call Lokar Technical Support.

Step 24: Once the installation is completely finished and the neutral safety switch is adjusted, remove each of the 5/16"-24 x 3/8" button head bolts from the banana brackets one at a time, apply blue thread locking compound to the threads, and reinstall.

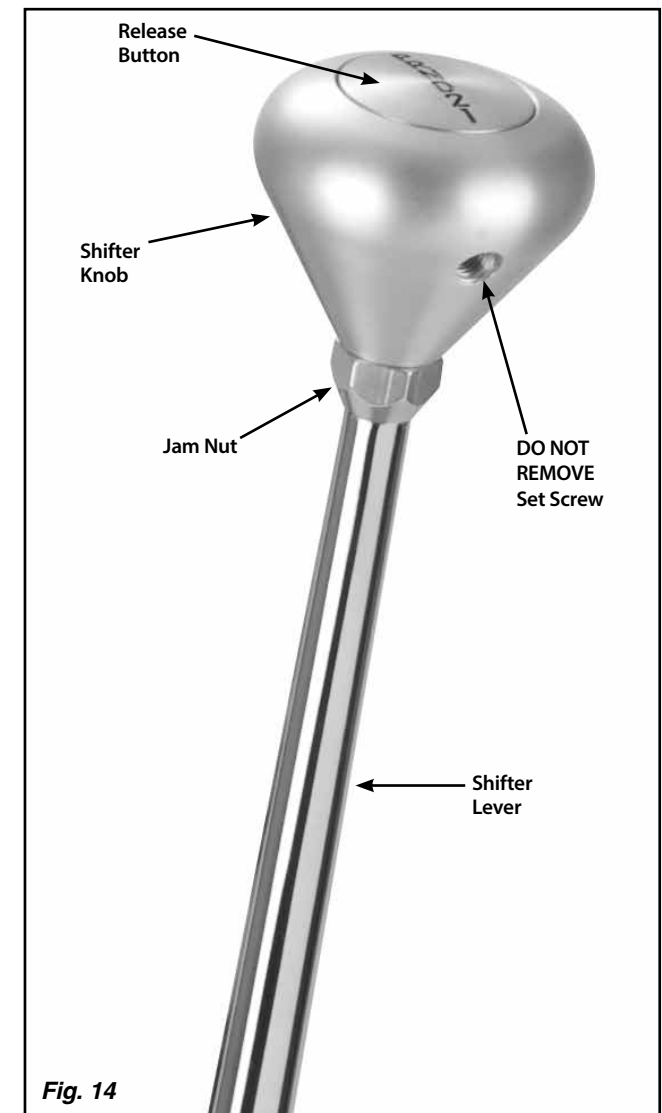
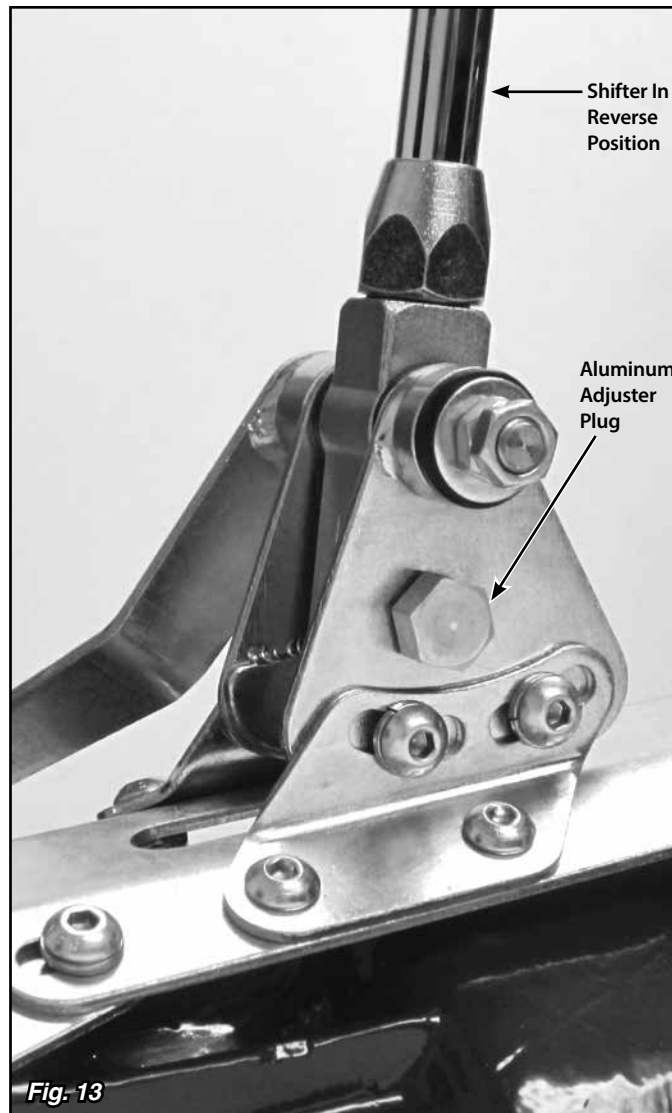

Lokar Shifter Knob Removal Instructions (For Shifters Manufactured 1995 and Later)

For shifters manufactured 1994 and earlier, please contact Lokar for assistance.

To Remove Shifter Knob:

Step 1: Make sure shifter is all the way forward in the Park position.

Step 2: Loosen the jam nut below the shifter knob. **DO NOT** loosen or remove the set screw that is in the knob. **Fig. 14**

Step 3: Turn the shifter knob counter-clockwise to remove.

To Install Shifter Knob:

Step 1: Make sure the jam nut is still in place on the shifter lever.

Step 2: Screw the shifter knob onto the shifter lever until the release button comes up flush with the top of the shifter knob.

Step 3: Tighten the jam nut up against the bottom of the shifter knob.

Step 4: Check to make sure that depressing the release button allows the shifter lever to be moved, and that the shifter lever still locks in Park and Neutral. If the shifter lever will not come out of "PARK" with the release button fully depressed, tighten the knob one turn and check it again. If the shifter lever does not lock in "PARK", loosen the knob one turn and check it again.